

Profilübersicht Eisenring

Wichtig!! Bitte sprechen Sie mit uns die optimale Dimension eines Profils ab, da die Rohmaterialdimension je nach Holzart abweichen kann.

Profile für Täfer, Bodenriemen, Dachschalungen und Hobelwaren



Nr. 2601-06-04 Rundprofil 15/113 mm, Softline

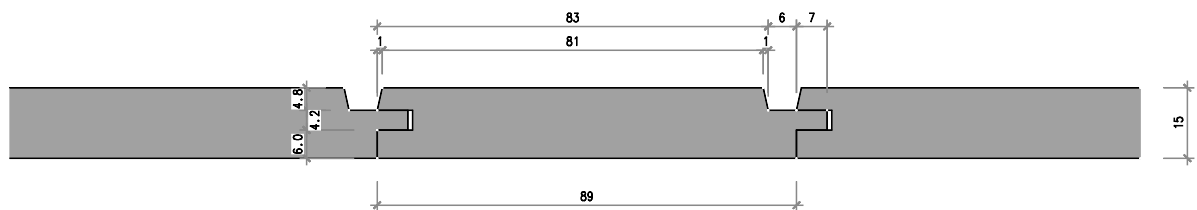

Nr. 2105-06-00 Sichtnuttäfer 15/89 mm, Nut 6 mm

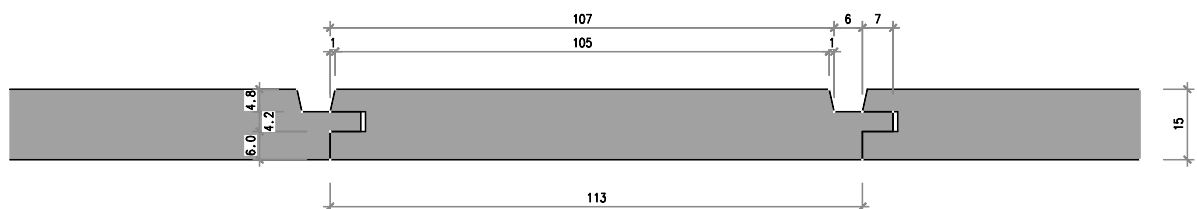

Nr. 2105-06-00 Sichtnuttäfer 15/113 mm, Nut 6 mm

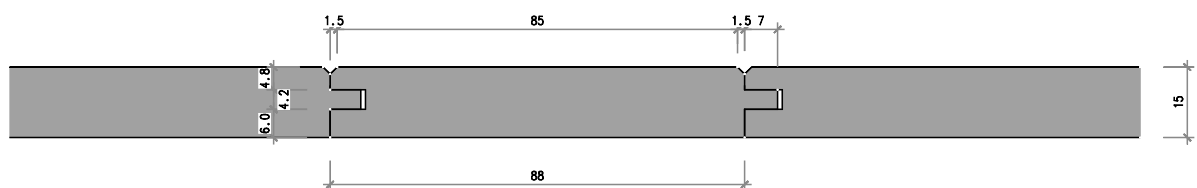

Nr. 1103-2k-01 Fastäfer 15/88 mm, Fase 1.5 mm



Nr. 1103-2k-01 Fastäfer 15/113 mm, Fase 1.5 mm

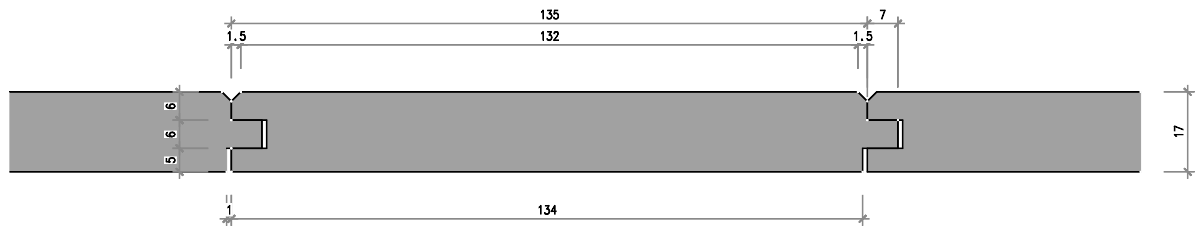

Nr. 1103-2k-01 Fastäfer 17/135 mm, Fase 1.5 mm

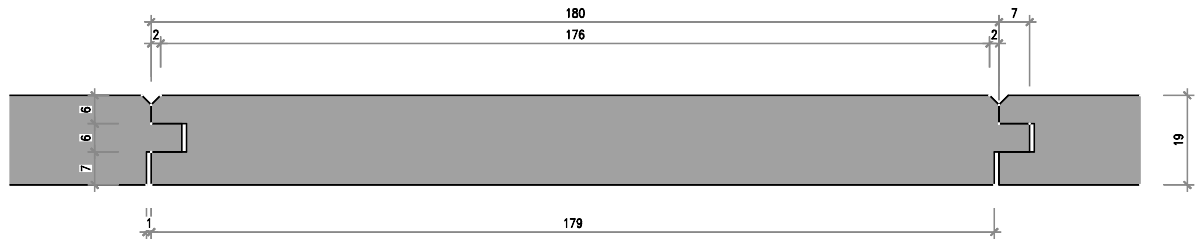

Nr. 1103-2k-01 Fastäfer 19/180 mm, Fase 1.5 mm

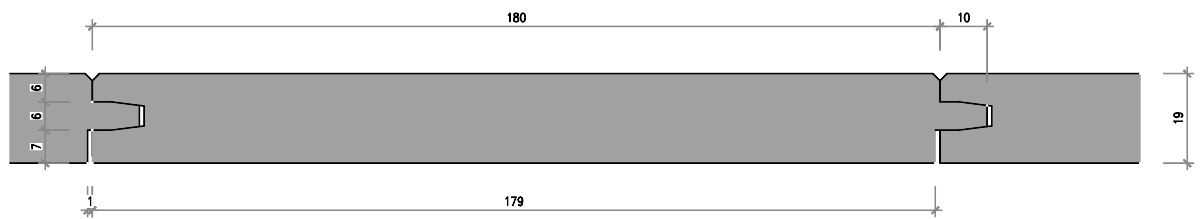

Nr. 4153-2k-01 Spezial Fastäfer 19/180 mm, Fase 1.5 mm

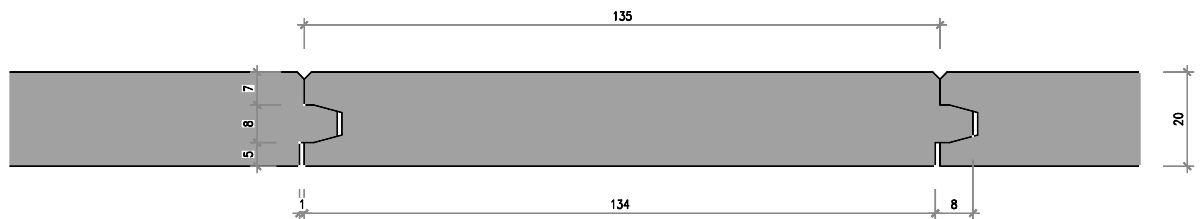

Nr. 4663-M2k-01 Spitzkamm 20/135 mm, Fase 1.5 mm

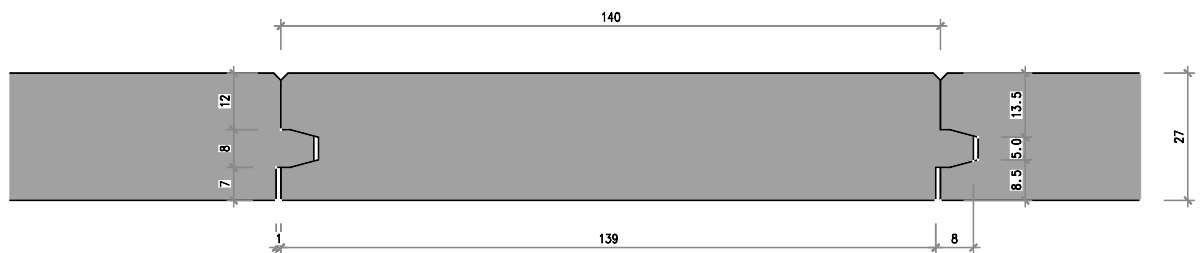

Nr. 4663-M2k-01 Spitzkamm 27/140 mm, Fase 1.5 mm

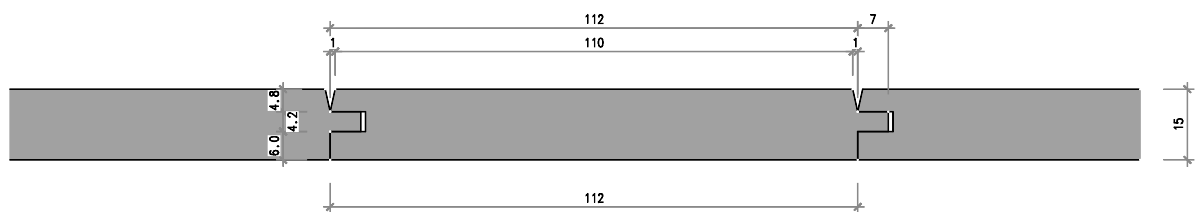

Nr. 1205-02-00 Steilfastäfer 15/112 mm

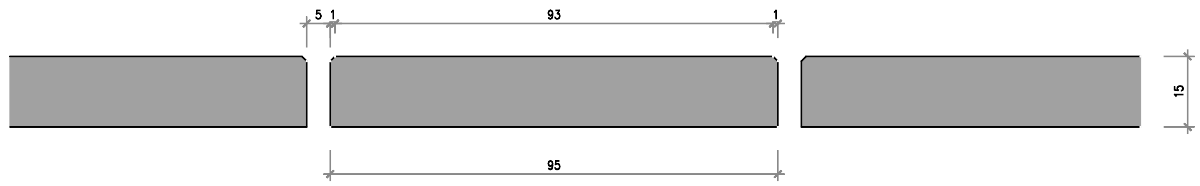

Nr. 6103-2k-01 Akustiktäfer 15/95 mm, Fase 1 mm



Nr. 6103-2k-01 Akustiktäfer 15/118 mm, Fase 1 mm



Nr. 6103-2k-02 Akustiktäfer 20/118 mm, Fase 2 mm

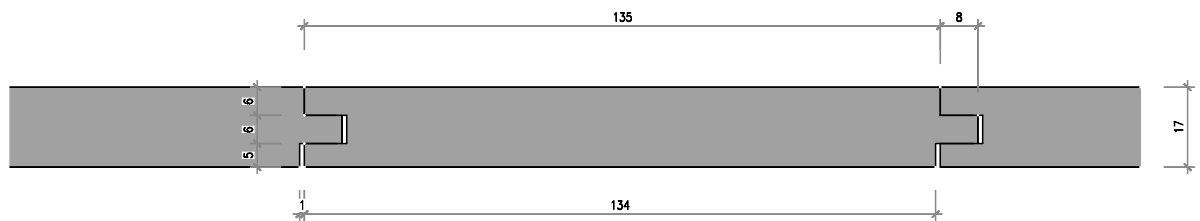

Nr. 4145-M N+K 17/135 mm, Kamm 8 mm lang parallel

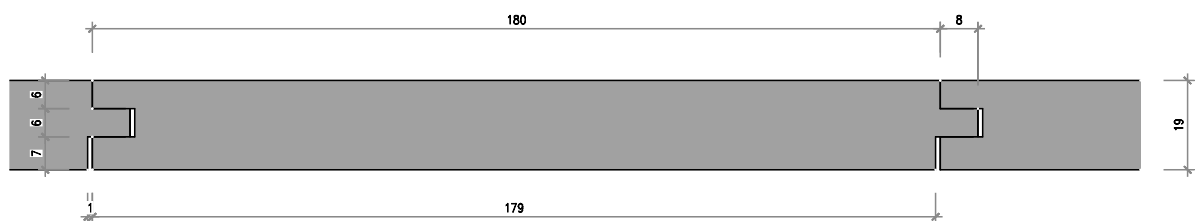

Nr. 4145-M N+K 19/180 mm, Kamm 8 mm lang parallel

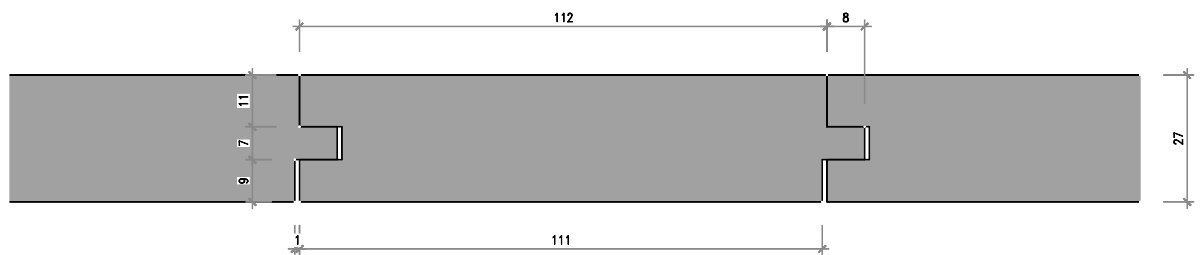

Nr. 4145-M Bodenriemen 27/112 mm

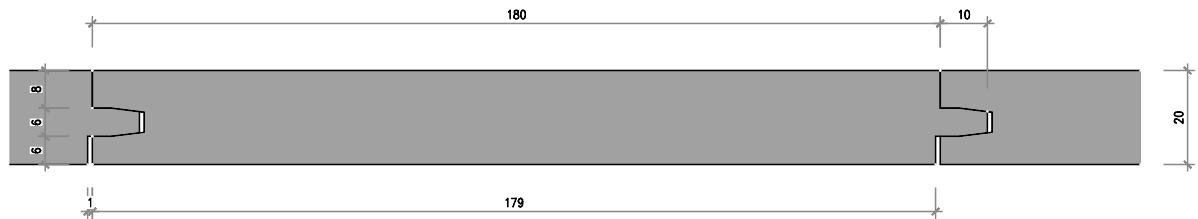

Nr. 4155-0k-00 Spezial N+K, Kamm 10 mm lang konisch

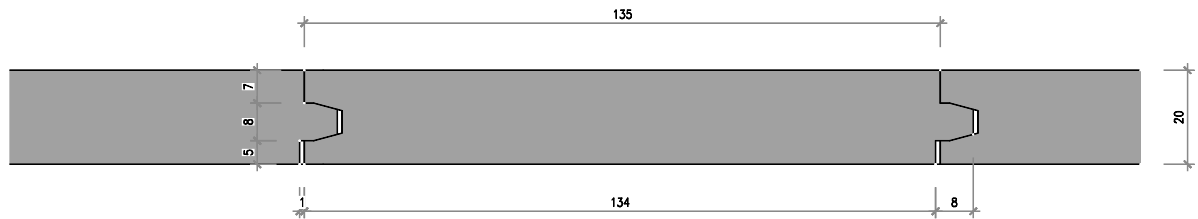

Nr. 4665-M Spitzkamm 20/135 mm

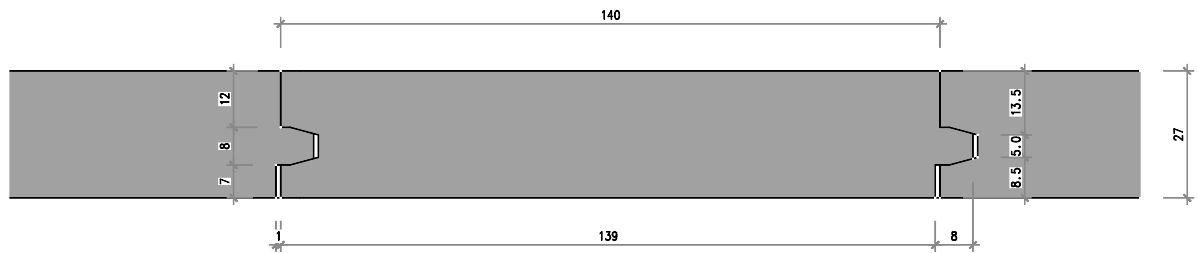

Nr. 4665-M Spitzkamm 27/140 mm

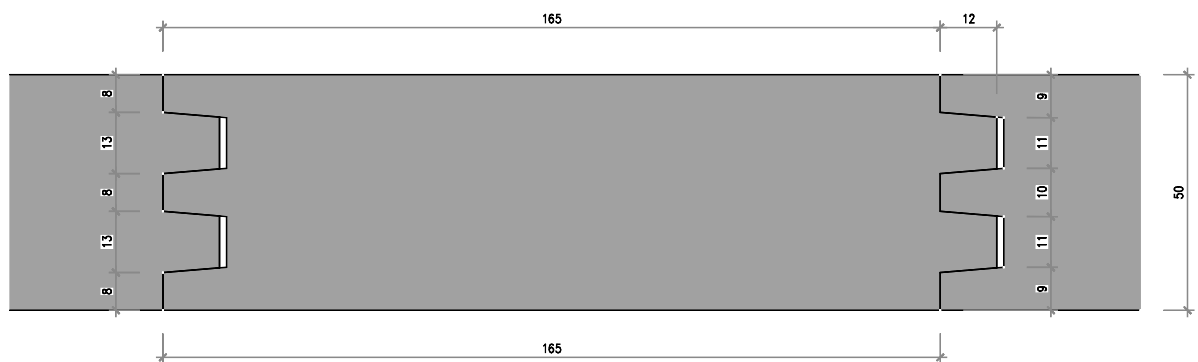

Nr. 4755-L Doppel-Nut und Kamm 50/165 mm

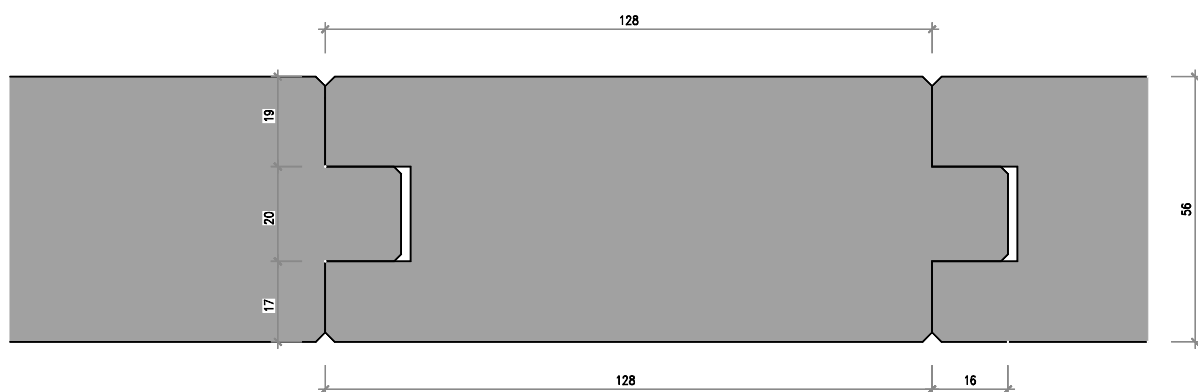

Nr. 4143-S4k-02 Strickwand 56/128 mm, Fase 4-seitig 2 mm

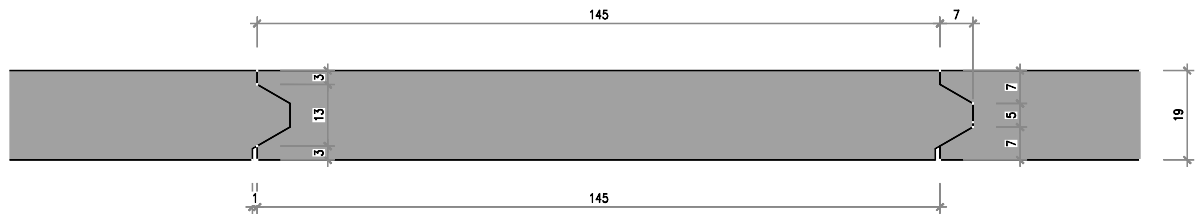

Nr. 4665-L Blindschalung 19/145 mm, Kamm 30°

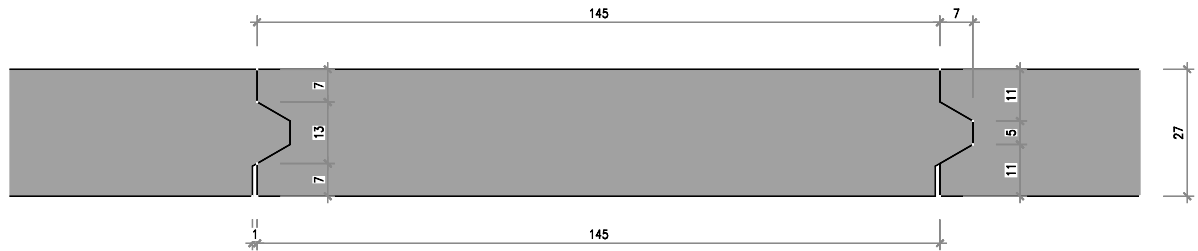

Nr. 4665-L Blindschalung 27/145 mm, Kamm 30°

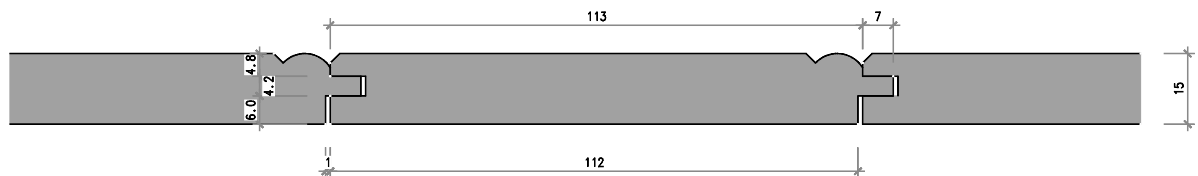

Nr. 5203-12-02 Krallentäfer 15/113 mm



Nr. 5100-10-00 Landhaustäfer 17/135 mm

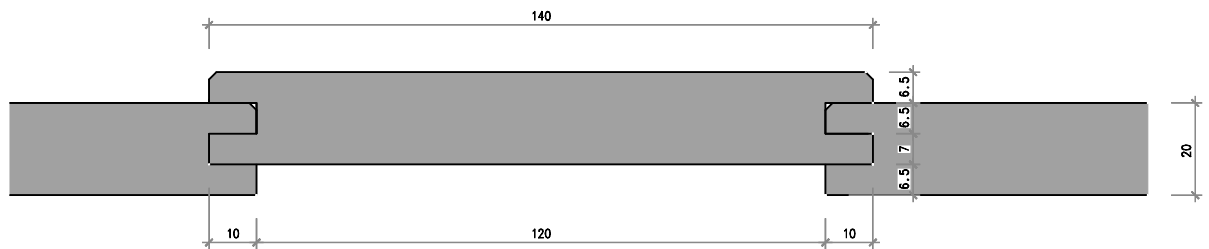

Nr. 6303-2k-01 Hoch-Tiefschalung 20/140 mm

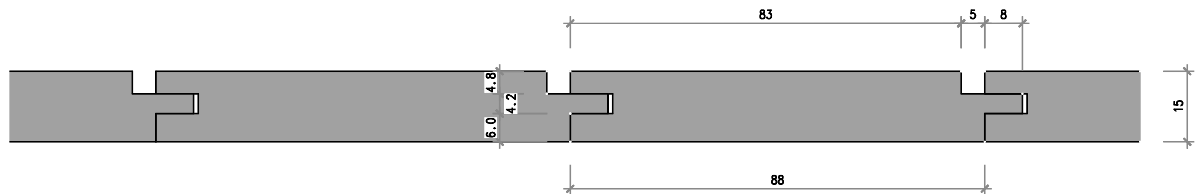

Nr. 2205-05-00 Spezial Sichtnuttäfer gerade 15/88 mm, Nut 5 mm

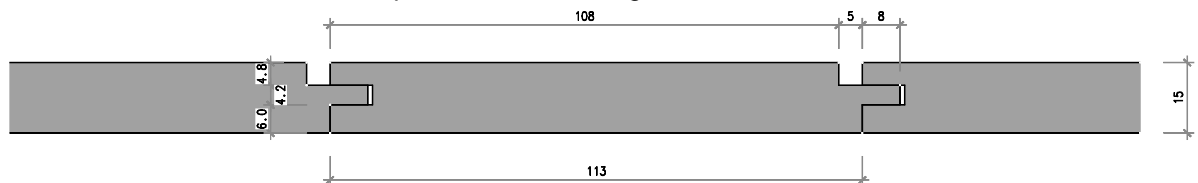

Nr. 2205-05-00 Spezial Sichtnuttäfer gerade 15/113 mm, Nut 5 mm

Profile für Fassaden (horizontale Montage)

Stülpschalung

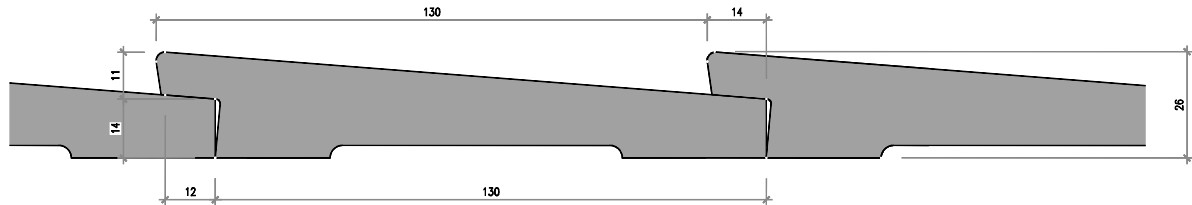

Nr. 7601-00-03 Stülpschalung Falz 14/26/130 mm, Rückseitig ausgekehlt



Nr. 7702-00-03 Stülpschalung N+K 14/26/122 mm, Rückseitig ausgekehlt

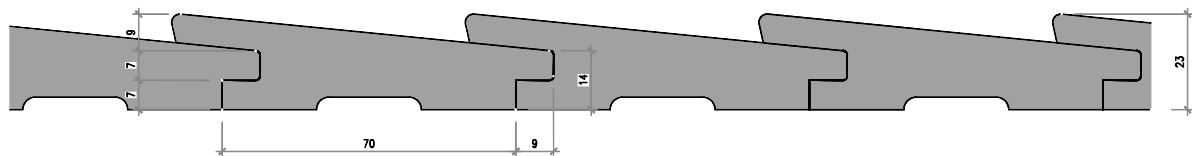

Nr. 7702-00-03 Stülpschalung N+K 14/23/70 mm, Rückseitig ausgekehlt

Rhomboid 20°

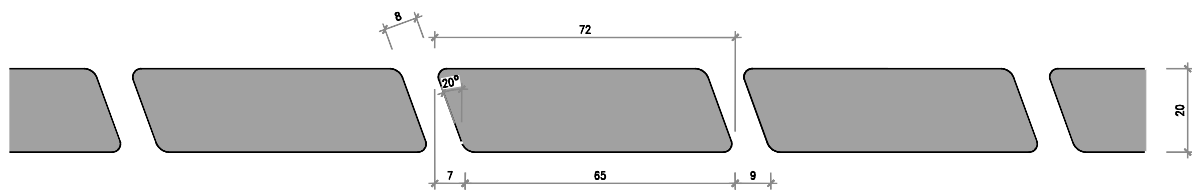

Nr. 6501-4k-03 Rhomboidschalung 20° 20/72 mm

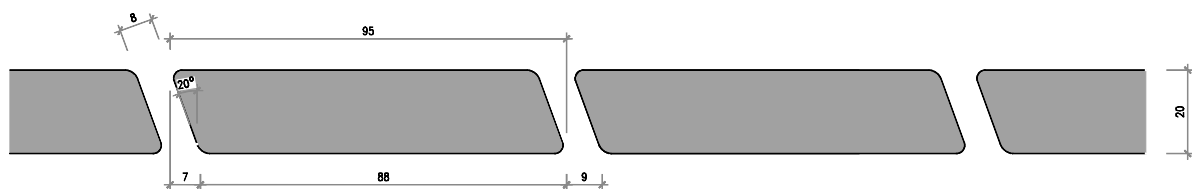

Nr. 6501-4k-03 Rhomboidschalung 20° 20/95 mm

Rhomboid N+K

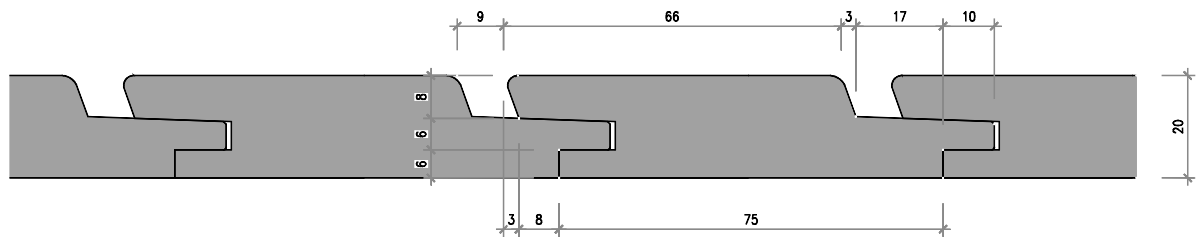

Nr. 6602-09-03

Rhomboidschalung N+K 20/75 mm

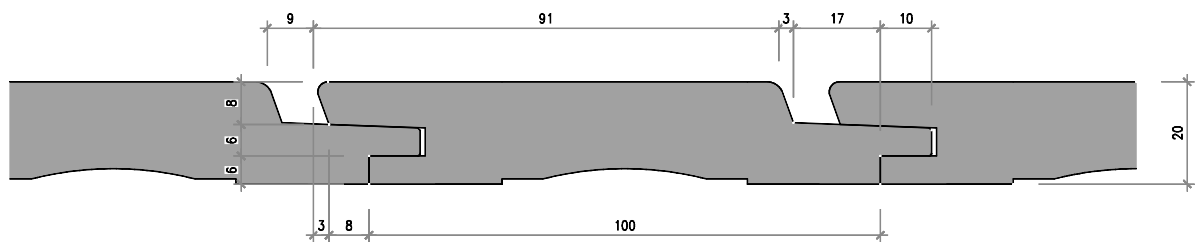

Nr. 6602-09-03

Rhomboidschalung N+K 20/100 mm

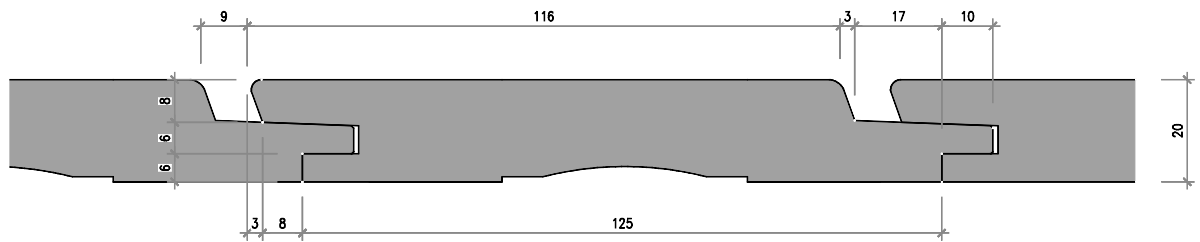

Nr. 6602-09-03

Rhomboidschalung N+K 20/125 mm

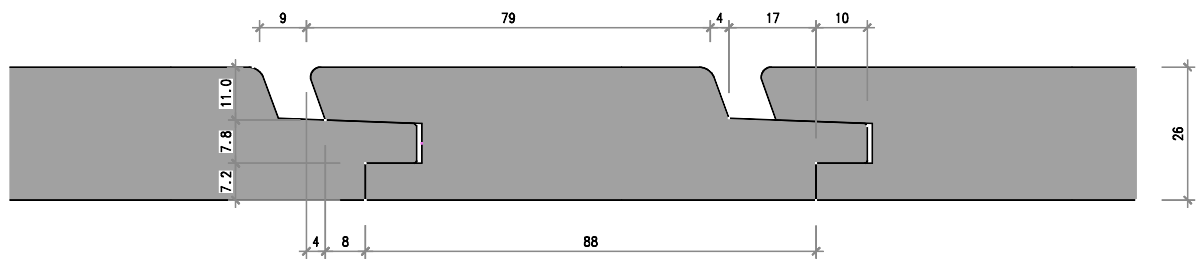

Nr. 6602-09-03

Rhomboidschalung N+K 26/88 mm

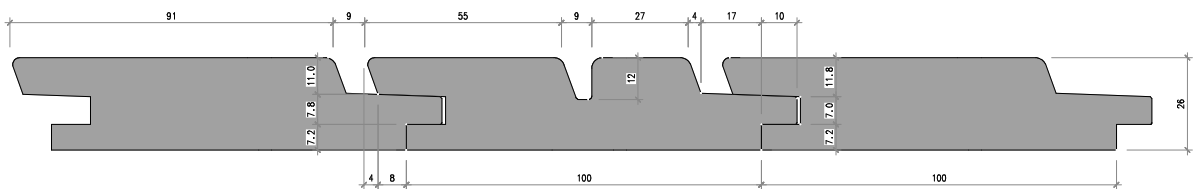

Nr. 6672-09-03

Rhomboid N+K Trio mit verschobener Mittelnut, Radius 3 mm, 3 Teile

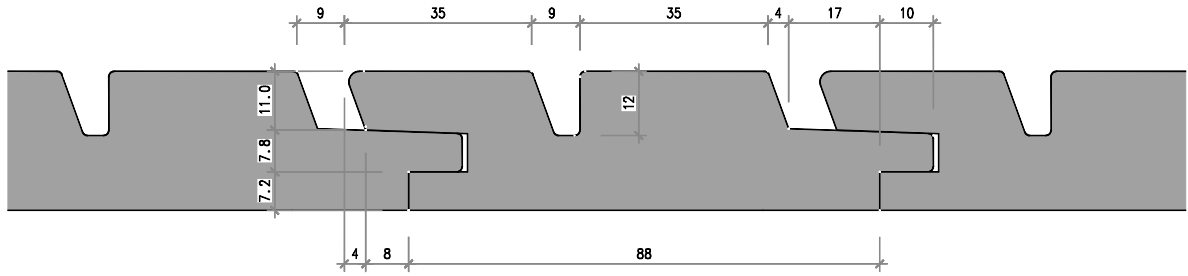

Nr. 6622-09-03 Rhomboid N+K 26/88 mm, mit Mittelnut

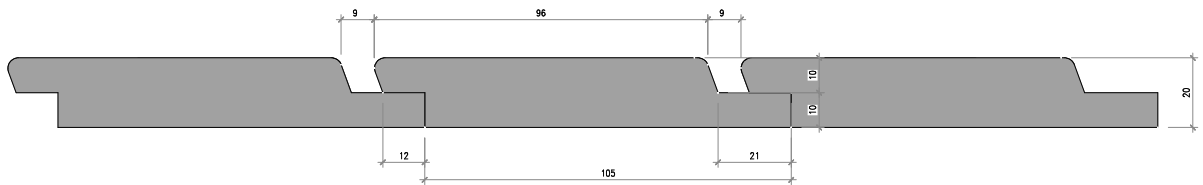

Nr. 6001-09-03 Wechselfalz mit Rhomboid 20°

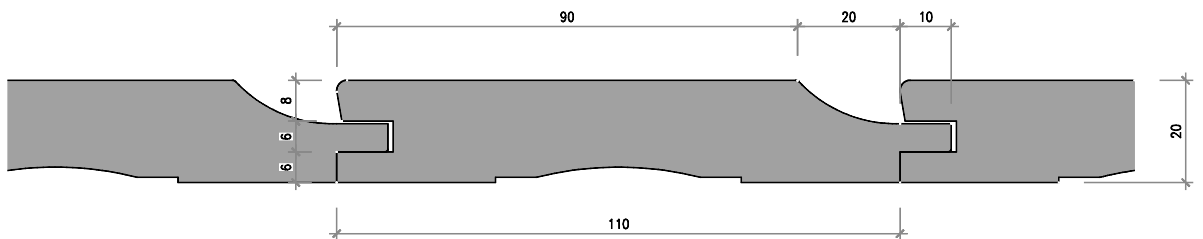

Nr. 7101-20-03 Chaletschalung 20/110 mm, ausgekehlt, Kante gerundet

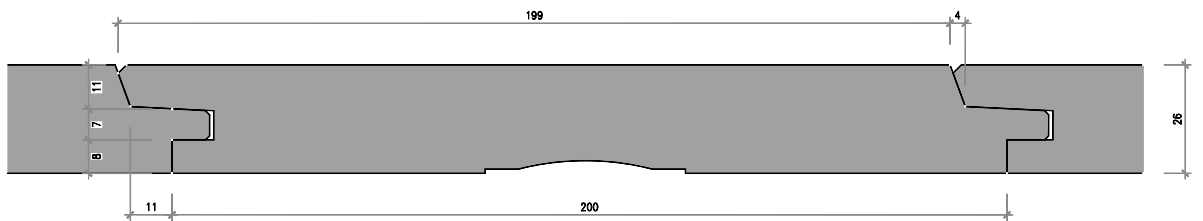

Nr. 6604-00-02 Strickwandimitation N+K 26/200 mm (Für nicht bewitterte Flächen)

Profile für Fassaden (vertikale Montage)

Sichtnut gerade

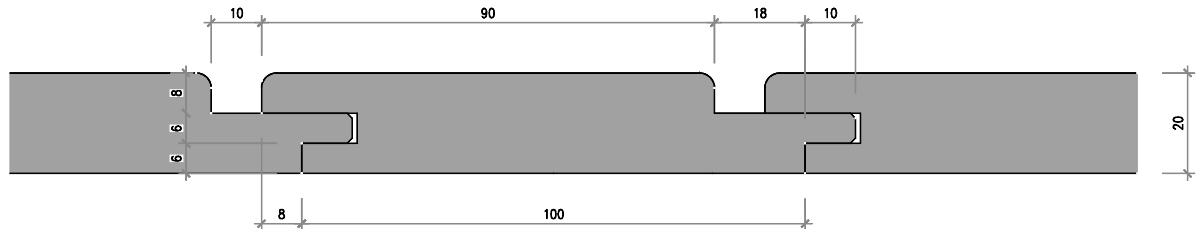

Nr. 2202-10-03 Sichtnutschalung gerade 20/100 mm, Nut 10 mm, Radius 3 mm

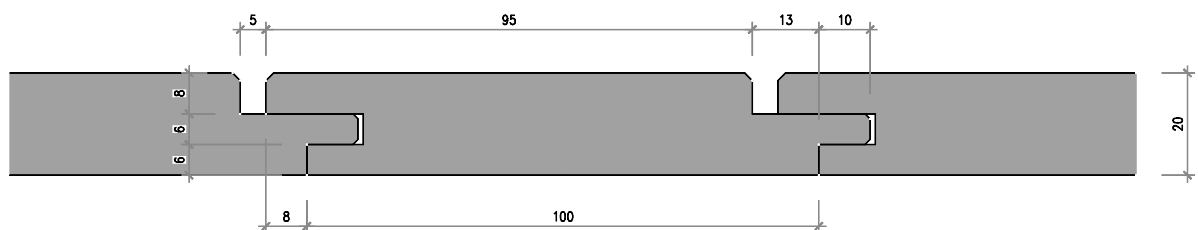

Nr. 2204-05-02 Sichtnutschalung gerade 20/100 mm, Fase 2 mm

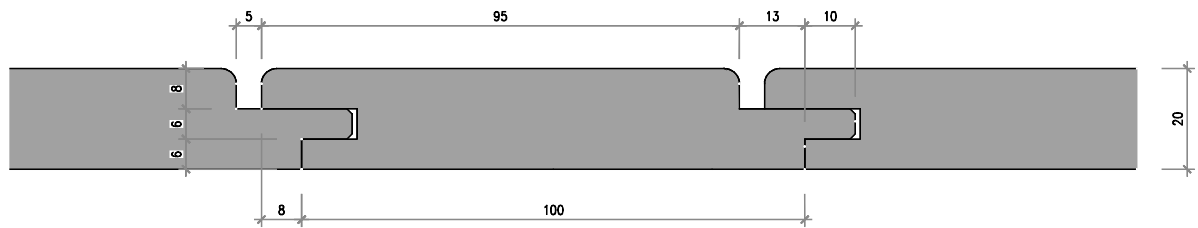

Nr. 2202-05-03 Sichtnutschalung gerade 20/100 mm, Nut 5 mm, Radius 3 mm

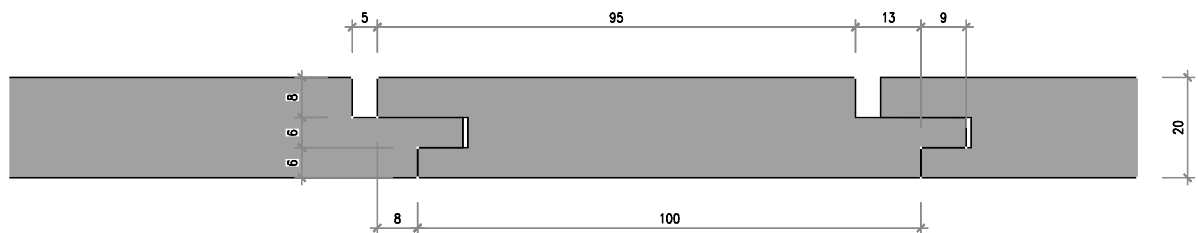

Nr. 2206-05-00 Sichtnutschalung gerade 20/100 mm, scharfkantig

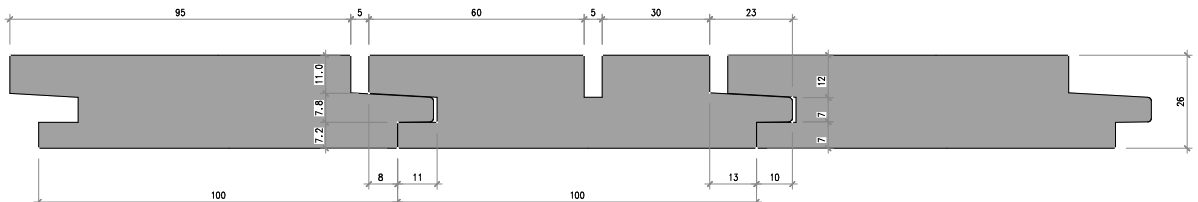

Nr. 2276-05-00 Sichtnut Trio gerade mit verschobener Mittelnut, 3 Teile

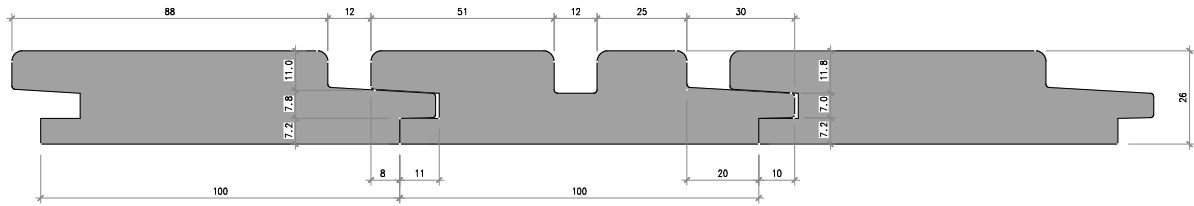

Nr. 2272-12-03 Sichtnut Trio gerade mit verschobener Mittelnut, 3 Teile

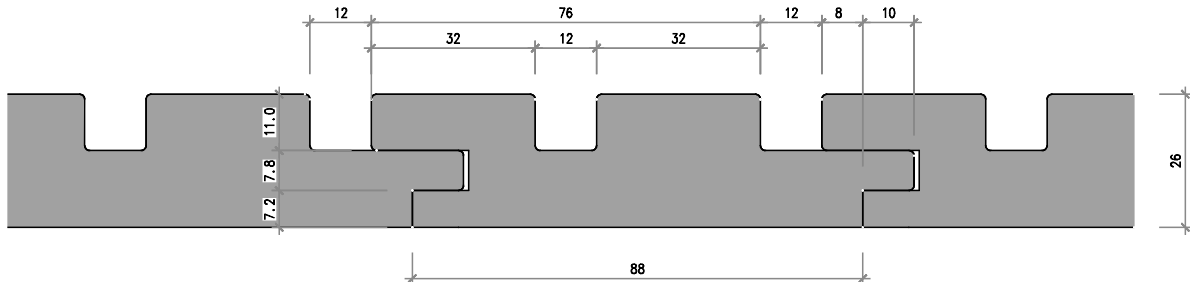

Nr. 2222-12-03 Sichtnutschalung gerade 26/88 mm mit Mittelnut, Kamm 10mm Für verdeckte Montage

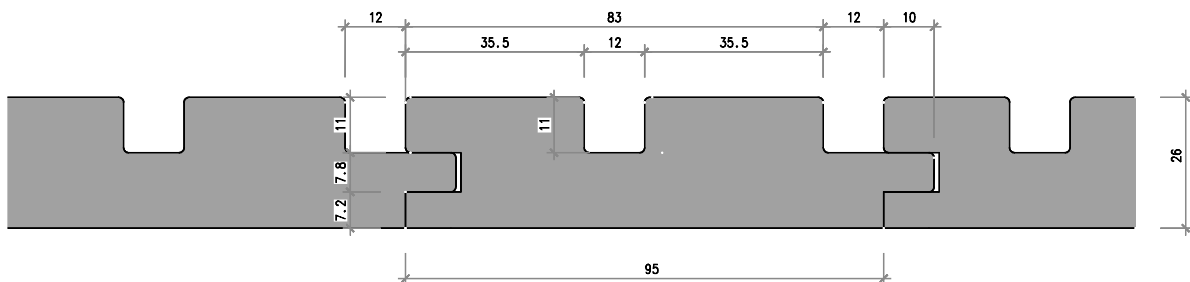

Nr. 2221-12-03 Sichtnutschalung gerade 26/95 mm mit Mittelnut, Kamm 10 mm

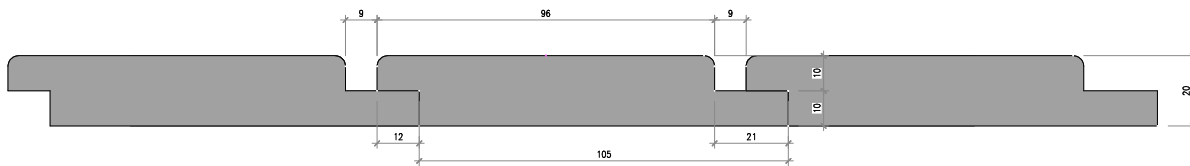

Nr. 8001-09-03 Wechselfalz mit Sichtnut gerade

Sichtnut 15°

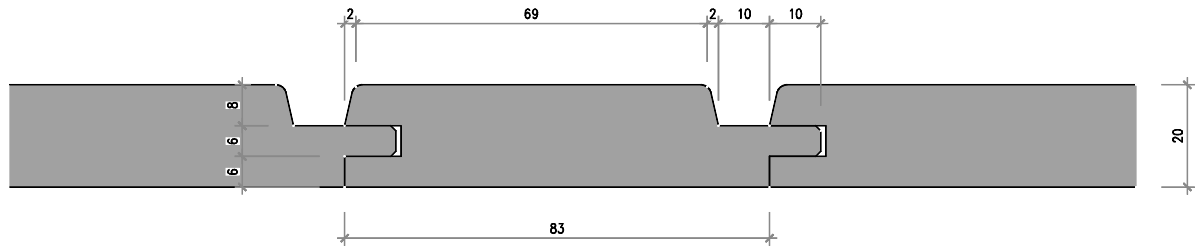

Nr. 2101-10-03

Sichtnut 20/83 mm, Nut 10 mm, Radius 3 mm

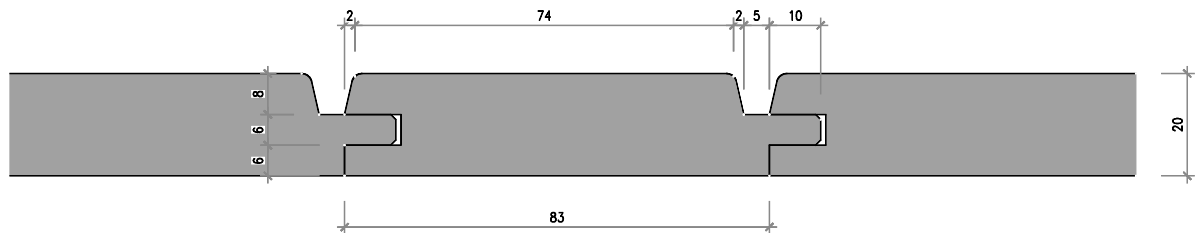

Nr. 2101-05-03

Sichtnut 20/83 mm, Nut 5 mm, Radius 3 mm

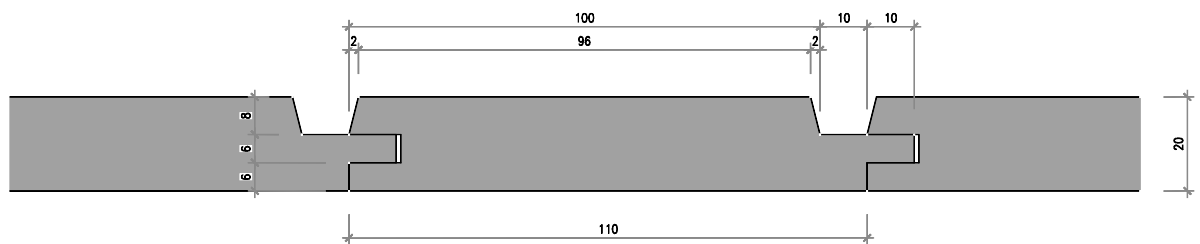

Nr. 2105-10-00

Sichtnuttäfer 20/110 mm, Nut 10 mm

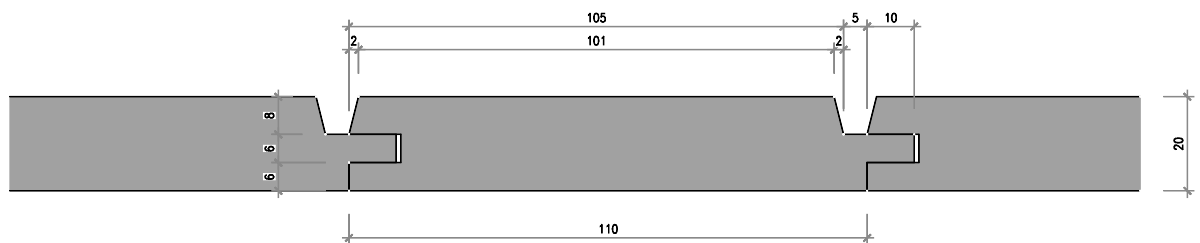

Nr. 2105-05-00

Sichtnuttäfer 20/110 mm, Nut 5 mm

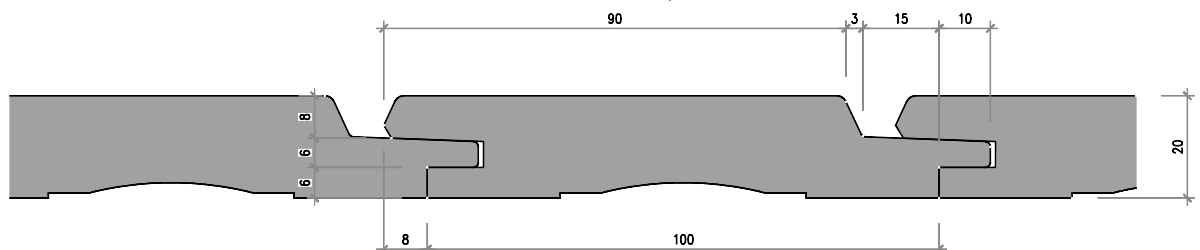

Nr. 2112-06-03

Sichtnut 20/100 mm, Radius 3 mm (Für verdeckte Montage)

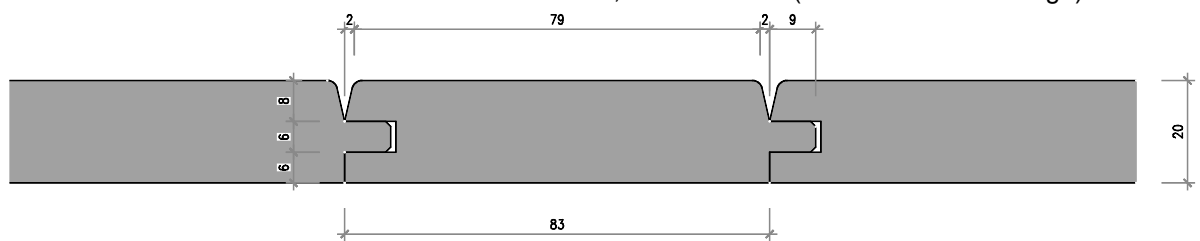

Nr. 1201-04-03

Steilfas 20/83 mm, Radius 3 mm

Schirmbretter

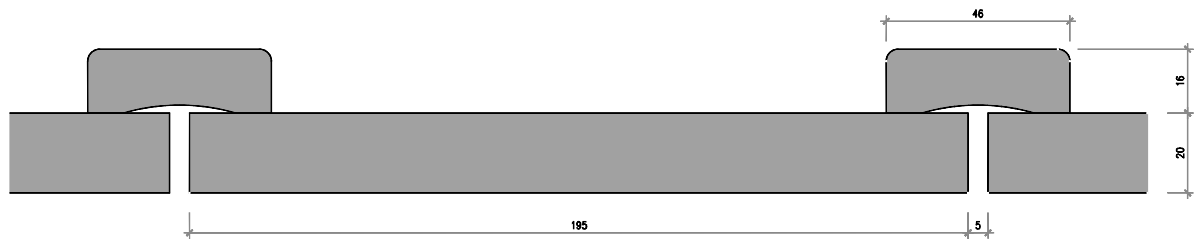

Nr. 81a01-2k-03
Nr. 8103-2k-01

Deckleiste Fichte 16/46 mm, ausgekehlt, Radius 3 mm
Schirmbretter 20/195 mm Grundbrett

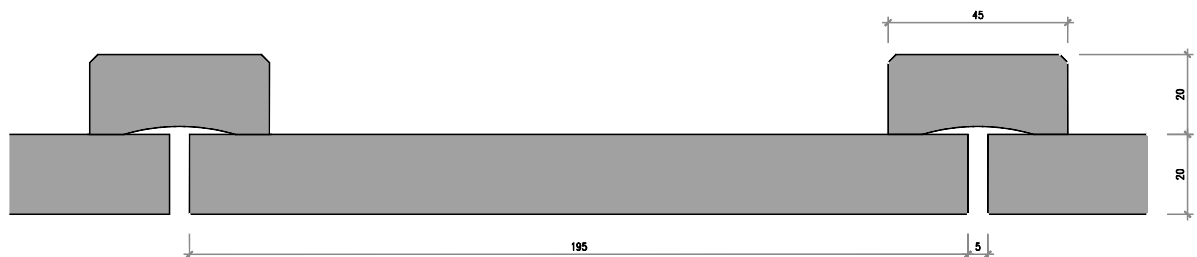

Nr. 81a03-2k-02
Nr. 8103-2k-01

Deckleiste Lärche 20/45 mm, ausgekehlt, Fase 3 mm
Schirmbretter 20/195 mm Grundbrett

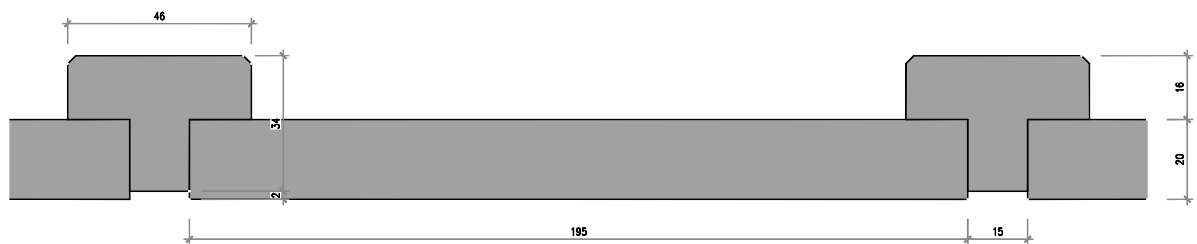

Nr. 81b03-15-02

T-Leiste 35/46 mm für Leistenschirm

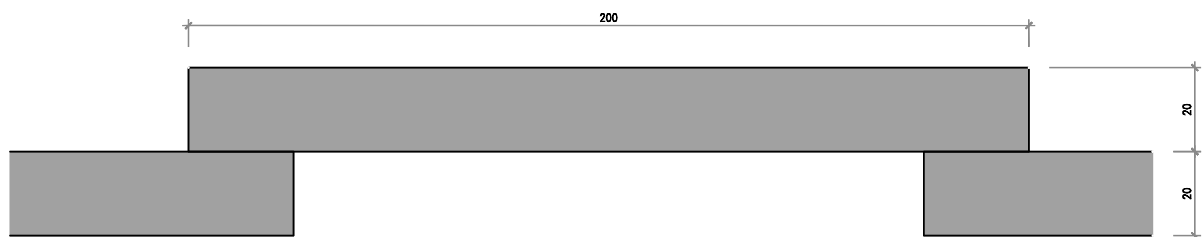

Nr. 8303-2k-02
Nr. 8103-2k-01

Deckelschalung Deckbrett 3-seitig sichtbar 20/200 mm
Schirmbretter Grundbrett 20/195 mm

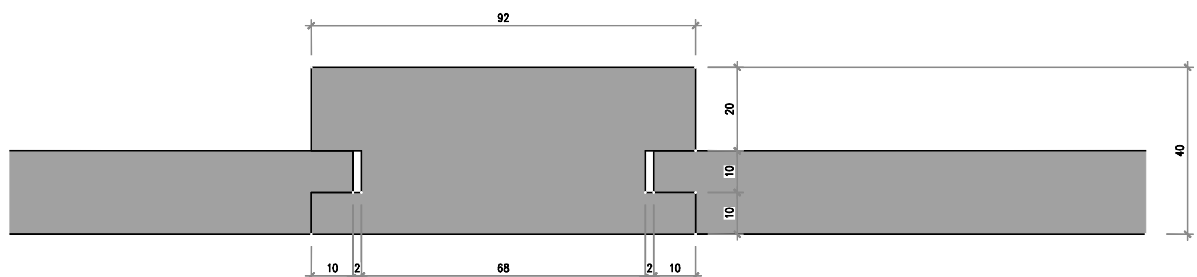

Nr. 83c05-4k-00
Nr. 83b03-2k-01

Deckbrett 3-seitig sichtbar 40/92 mm, Nut 10/12 mm
Grundbrett (wie T-Leiste), Falz 10/10 mm

Profile für Terrassen

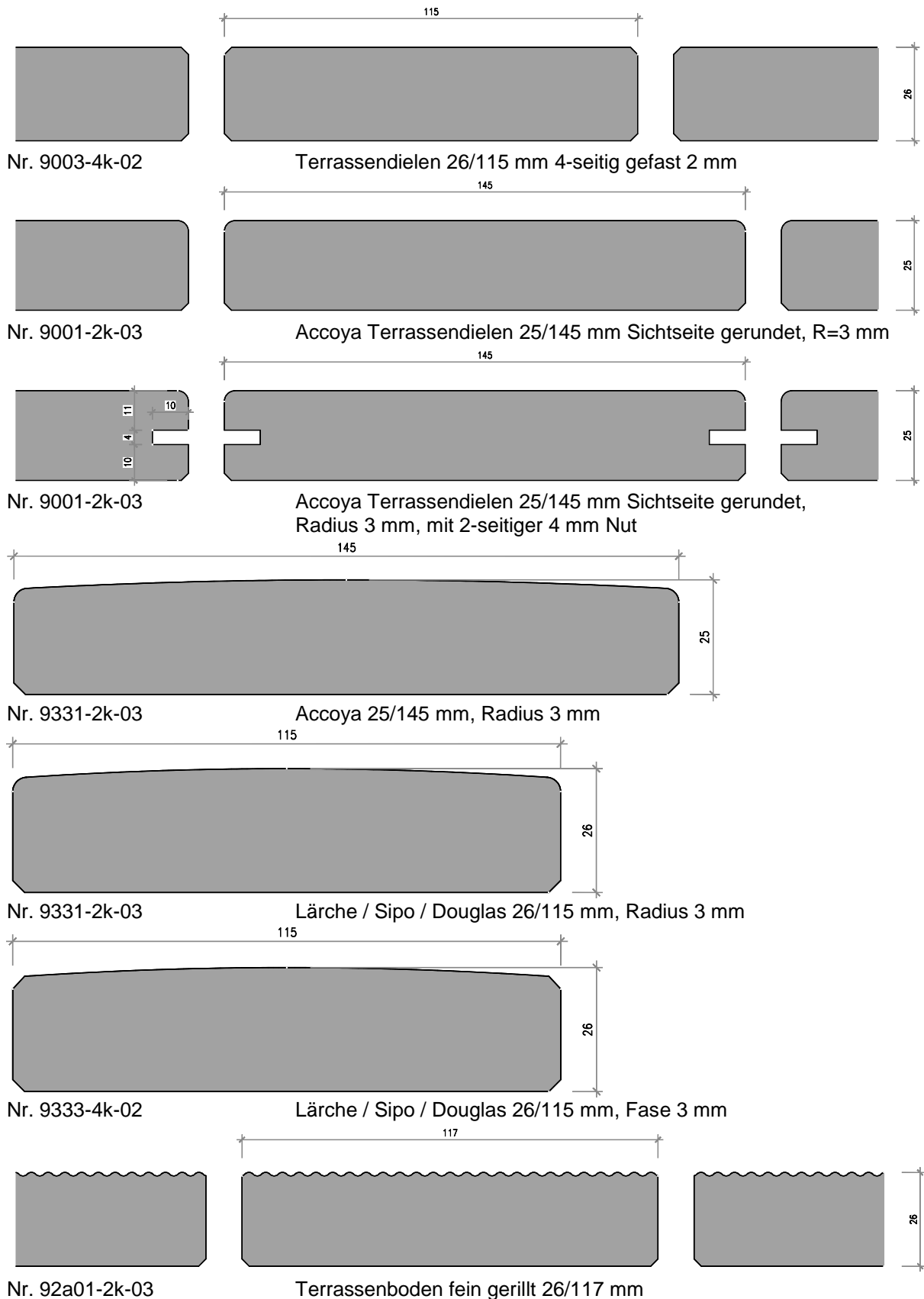

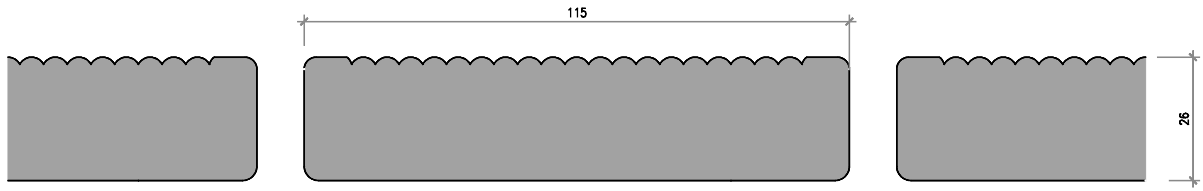

Nr. 92b01-2k-03

Terrassenboden geriffelt 26/115 mm

Spezialprofile

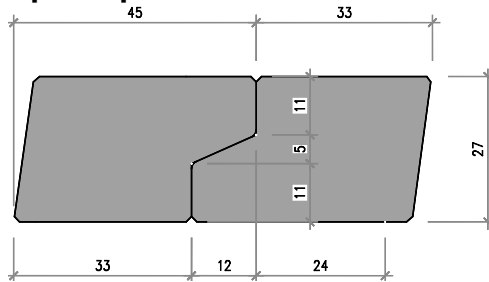

Nr. 9503-4k-01

Einhängelatten für Wand- und Fassadenelemente 27/45 mm

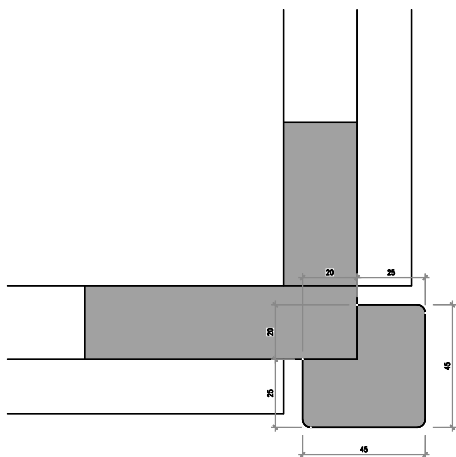

Nr. 82b01-3k-03

Fassadeneckprofil L 45/45 mm, 20/20 mm ausgekehlt, Radius 3 mm

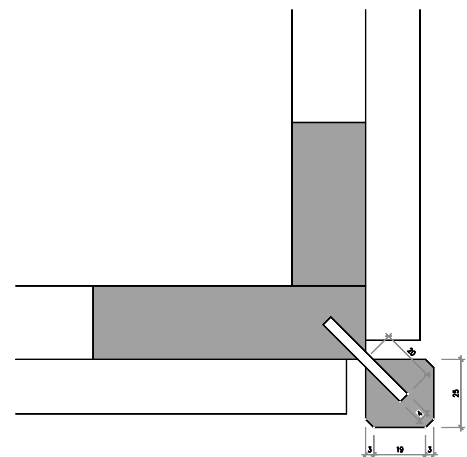

Nr. 82c03-3k-01

Fassadeneckprofil Smart 25/25 mm mit 4/20 mm Nut, Fase 3 mm

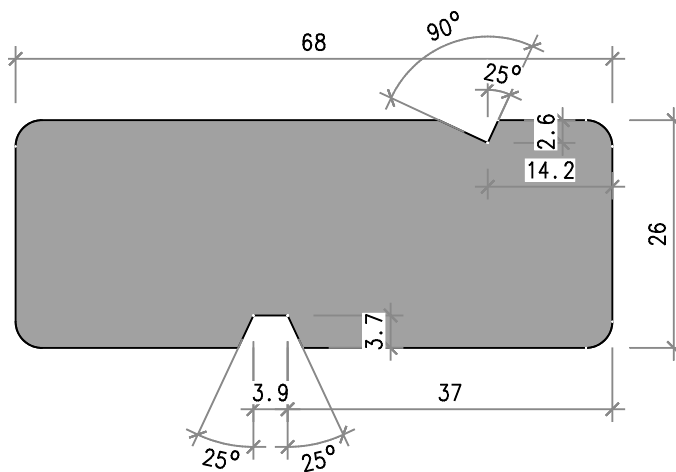

Nr. 6101-CA-03

Cadex Sichtschutz 26/88 mm